

Notice: You cannot copy or search for text in this PDF file, because this PDF file is converted from the scanned image of printed materials.

P1 98.2

N-CHANNEL MOS FET
FOR SWITCHING

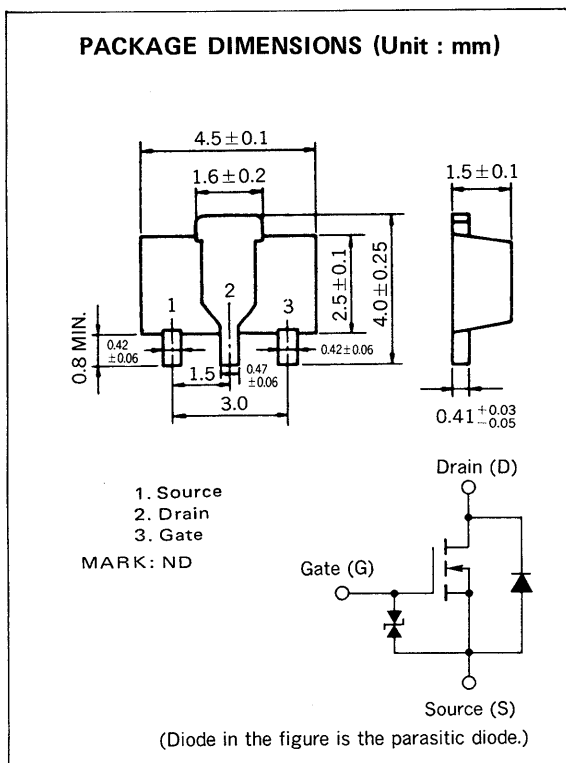

The 2SK1583 is an N-channel vertical type MOS FET which can be driven by 2.5 V power supply.

As the MOS FET is driven by low voltage and does not require consideration of driving current, it is suitable for appliances including VCR cameras and headphone stereos which need power saving.

FEATURES

- Directly driven by ICs having a 3 V power supply.
- Has low on-state resistance
 $R_{DS(on)1} = 2.0 \Omega \text{ MAX. @ } V_{GS} = 2.5 \text{ V, } I_D = 0.3 \text{ A}$
 $R_{DS(on)2} = 1.5 \Omega \text{ MAX. @ } V_{GS} = 4.0 \text{ V, } I_D = 0.3 \text{ A}$

QUALITY GRADE

Standard

Please refer to "Quality grade on NEC Semiconductor Devices" (Document number IEI-1209) published by NEC Corporation to know the specification of quality grade on the devices and its recommended applications.

ABSOLUTE MAXIMUM RATINGS ($T_a = 25^\circ\text{C}$)

| PARAMETER | SYMBOL | RATINGS | UNIT | TEST CONDITIONS |
|-------------------------|---------------------|------------------------|------------------|---|
| Drain to Source Voltage | V_{DSS} | 16 | V | $V_{GS} = 0$ |
| Gate to Source Voltage | V_{GSS} | ± 16 | V | $V_{DS} = 0$ |
| Drain Current | $I_D(\text{DC})$ | ± 0.5 | A | |
| Drain Current | $I_D(\text{pulse})$ | ± 1.0 | A | $PW \leq 10 \text{ ms, Duty Cycle} \leq 50 \%$ |
| Total Power Dissipation | P_T | 2.0 | W | when using ceramic board of $16 \text{ cm}^2 \times 0.7 \text{ mm}$ |
| Channel Temperature | T_{ch} | 150 | $^\circ\text{C}$ | |
| Operating Temperature | T_{opt} | $-55 \text{ to } +80$ | $^\circ\text{C}$ | |
| Storage Temperature | T_{stg} | $-55 \text{ to } +150$ | $^\circ\text{C}$ | |

ELECTRICAL CHARACTERISTICS (T_a = 25 °C)

| PARAMETER | SYMBOL | MIN. | TYP. | MAX. | UNIT | TEST CONDITIONS |
|-------------------------------------|----------------------|------|------|------|------|---|
| Drain Cut-off Current | I _{DSS} | | | 1.0 | μA | V _{DS} = 16 V, V _{GS} = 0 |
| Gate Leakage Current | I _{GSS} | | | ±5.0 | μA | V _{GS} = ±16 V, V _{DS} = 0 |
| Gate Cut-off Voltage | V _{GS(off)} | 0.8 | 1.0 | 1.6 | V | V _{DS} = 5 V, I _D = 1 mA |
| Forward Transfer Admittance | y _{fs} | 400 | 550 | | mS | V _{DS} = 5 V, I _D = 0.3 A |
| Drain to Source On-State Resistance | R _{DS(on)1} | | 1.8 | 2.0 | Ω | V _{GS} = 2.5 V, I _D = 0.3 A |
| Drain to Source On-State Resistance | R _{DS(on)2} | | 0.8 | 1.5 | Ω | V _{GS} = 4.0 V, I _D = 0.3 A |
| Input Capacitance | C _{iss} | | 60 | | pF | V _{DS} = 5 V, V _{GS} = 0, f = 1 MHz |
| Output Capacitance | C _{oss} | | 70 | | pF | |
| Feedback Capacitance | C _{rss} | | 15 | | pF | |
| Turn-On Delay Time | t _{d(on)} | | 95 | | ns | V _{GS(on)} = 3 V, R _G = 10 Ω V _{DD} = 10 V, I _D = 0.3 A R _L = 33 Ω |
| Rise Time | t _r | | 360 | | ns | |
| Turn-Off Delay Time | t _{d(off)} | | 160 | | ns | |
| Fall Time | t _f | | 150 | | ns | |

SWITCHING TIME MEASUREMENT CIRCUIT AND CONDITIONS

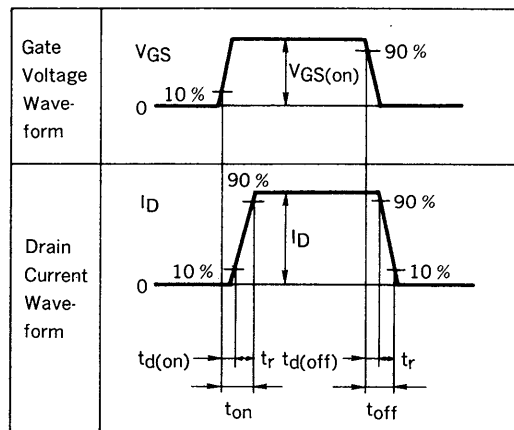
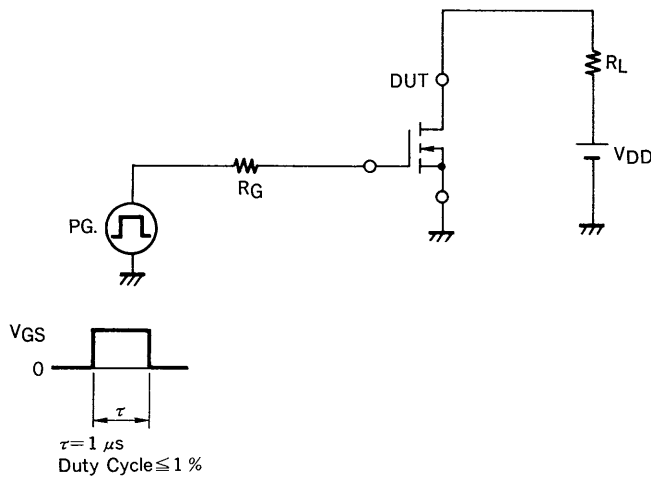

TYPICAL CHARACTERISTICS ($T_a = 25^\circ\text{C}$)

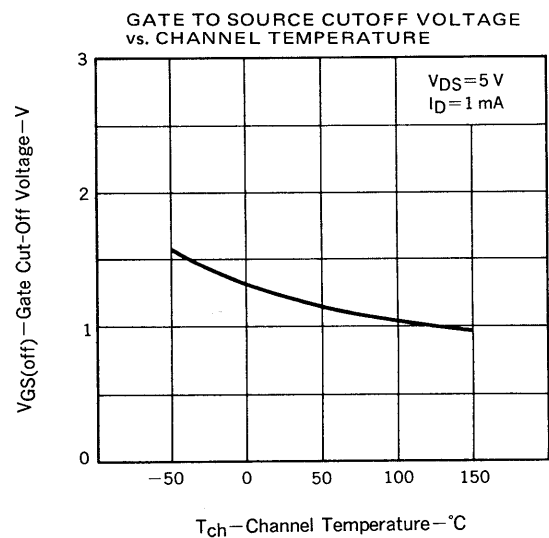
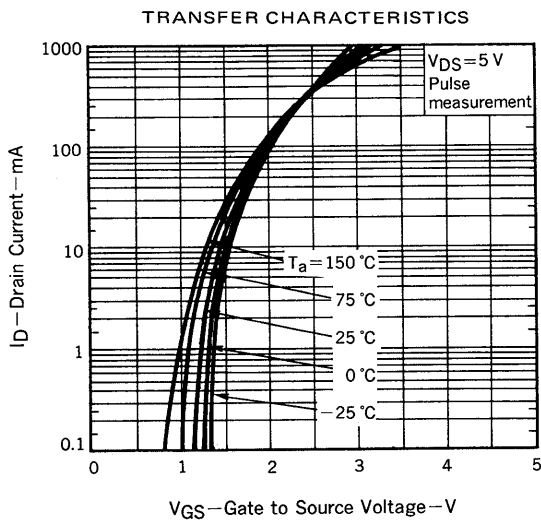
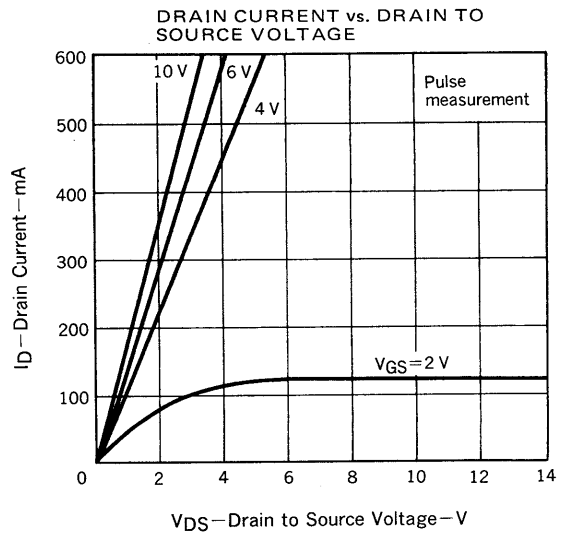
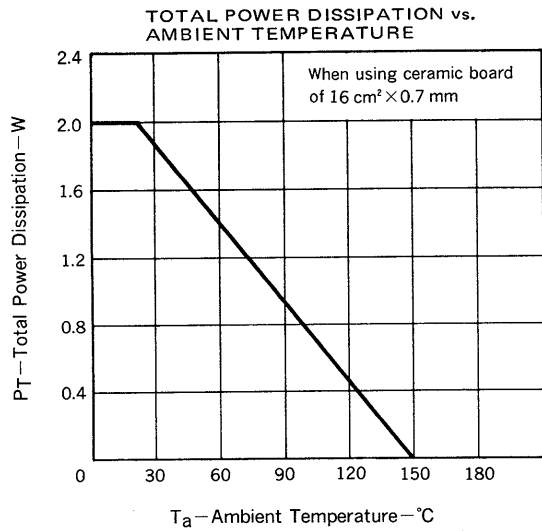
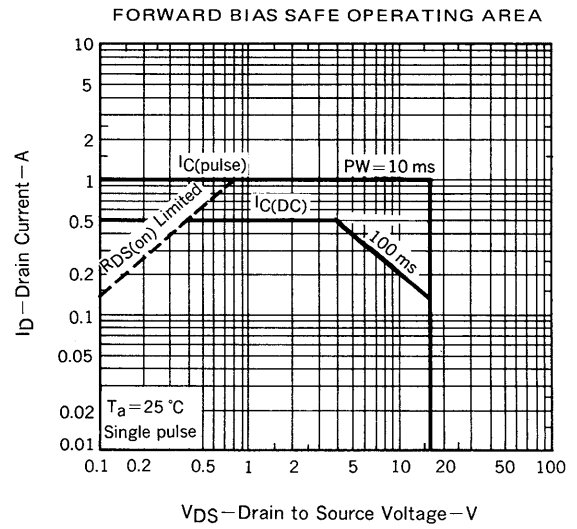
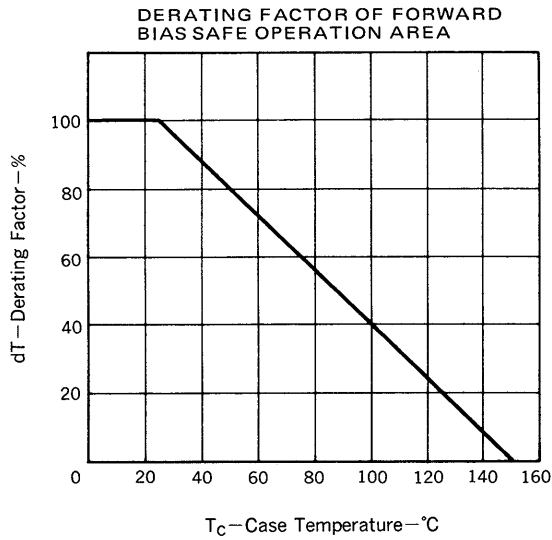

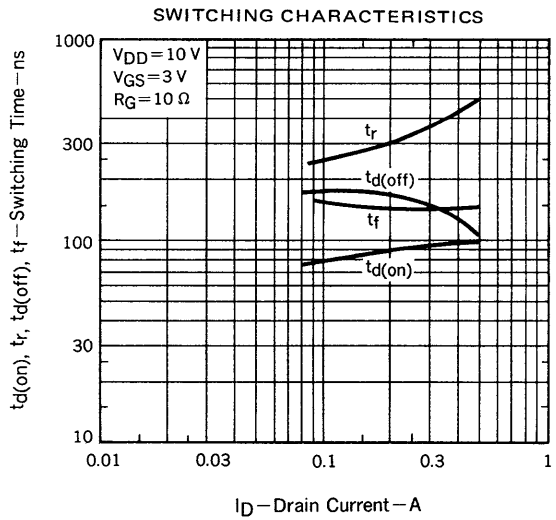
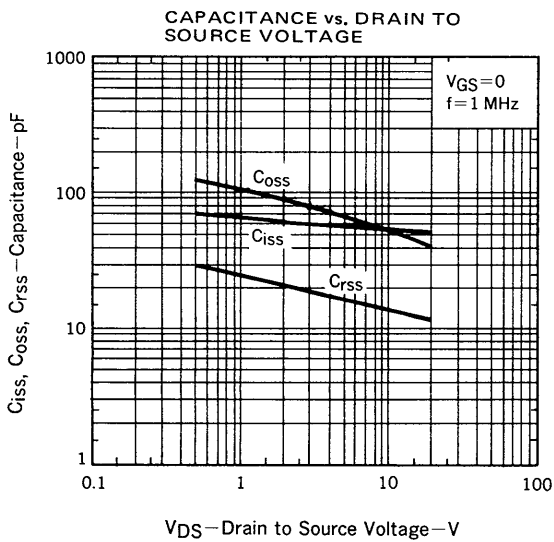
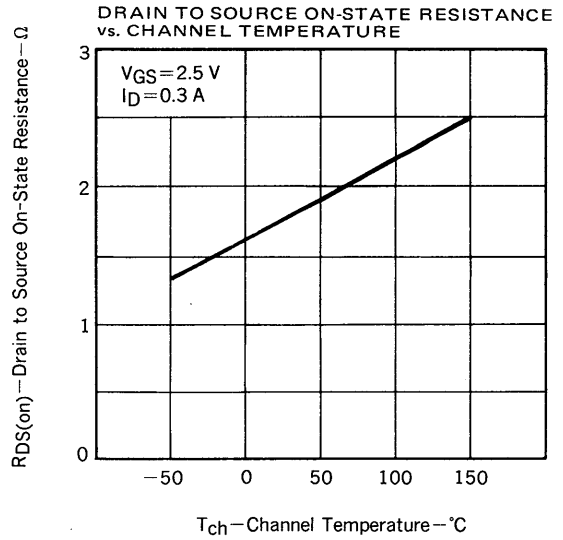
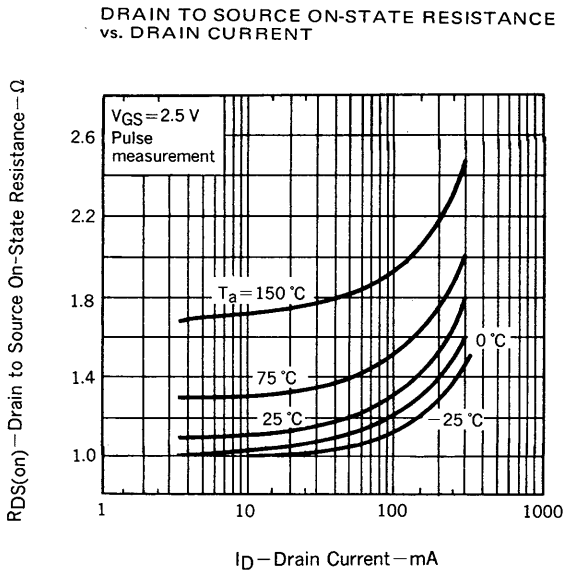
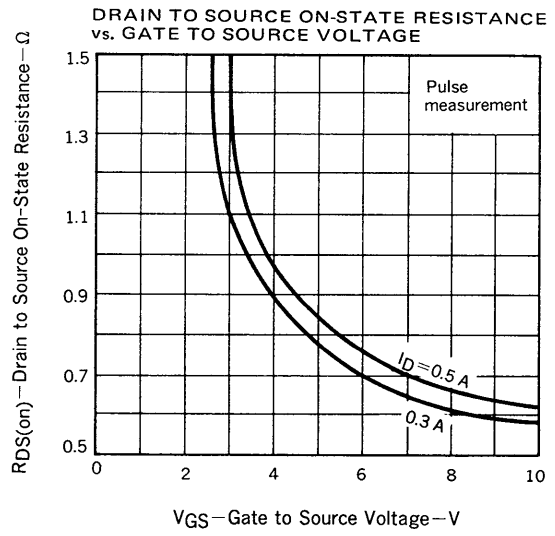
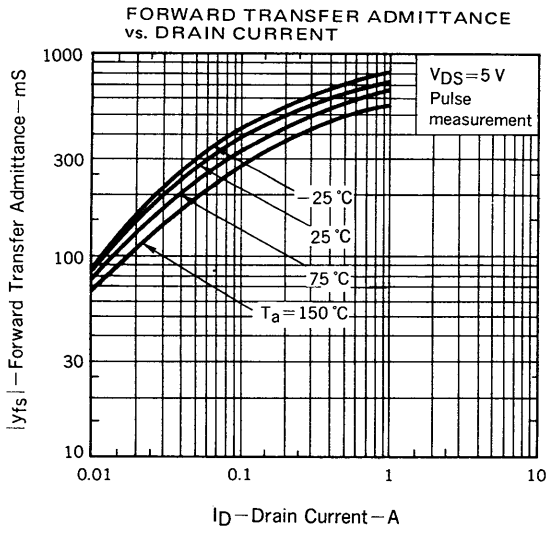

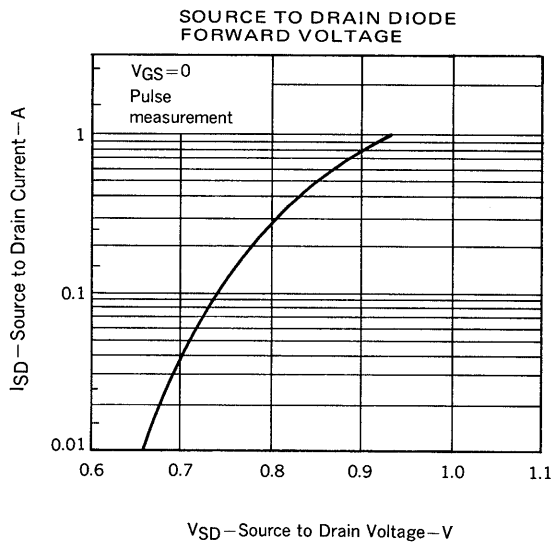

RECOMMENDED SOLDERING CONDITIONS

Mounting of this product by soldering should be done under the following conditions.
Please consult our representatives about soldering methods and conditions other than these.

SURFACE MOUNT TYPE

For details of the recommended soldering conditions, see the information document.
“Device Mounting Manual for Surface Mounting (IEI-1207).”

| Soldering Method | Soldering Conditions | Symbol for Recommended Conditions |
|-----------------------|--|-----------------------------------|
| Infrared Reflow | Package peak temp.: 230 °C Soldering time: within 30 sec (above 210 °C) Soldering times: 1, Days limitation: none* | IR30-00 |
| Vapor Phase Soldering | Package peak temp.: 215 °C Soldering time: within 40 sec (above 200 °C) Soldering times: 1, Days limitation: none* | VP15-00 |
| Wave Soldering | Soldering bath temp.: below 260 °C Soldering time: within 10 sec Soldering times: 1, Days limitation: none* | WS60-00 |

*: Stored days under storage conditions at 25 °C and below 65 % R.H. after the dry-pack has been opened.

Note 1 Combination of soldering methods should be avoided.

REFERENCE

| Document Name | Document No. |
|--|--------------|
| NEC semiconductor device reliability/quality control system. | TEI-1202 |
| Quality grade on NEC semiconductor devices. | IEI-1209 |
| Semiconductor device mounting technology manual. | IEI-1207 |
| Semiconductor device package manual. | IEI-1213 |
| Guide to quality assurance for semiconductor devices. | MEI-1202 |
| Semiconductor selection guide. | MF-1134 |

No part of this document may be copied or reproduced in any form or by any means without the prior written consent of NEC Corporation. NEC Corporation assumes no responsibility for any errors which may appear in this document.

NEC Corporation does not assume any liability for infringement of patents, copyrights or other intellectual property rights of third parties by or arising from use of a device described herein or any other liability arising from use of such device. No license, either express, implied or otherwise, is granted under any patents, copyrights or other intellectual property rights of NEC Corporation or others.

The devices listed in this document are not suitable for use in aerospace equipment, submarine cables, nuclear reactor control systems and life support systems. If customers intend to use NEC devices for above applications or they intend to use "Standard" quality grade NEC devices for applications not intended by NEC, please contact our sales people in advance.

Application examples recommended by NEC Corporation

Standard: Computer, Office equipment, Communication equipment, Test and Measurement equipment, Machine tools, Industrial robots, Audio and Visual equipment, Other consumer products, etc.

Special: Automotive and Transportation equipment, Traffic control systems, Antidisaster systems, Anticrime systems, etc.